

PEXP182T-3-4

Premium Efficient Explosion Proof Motor

Class I, Division I, Groups C & D and Class II, Division I, Groups E, F and G - Operating Temperature Code: T3C

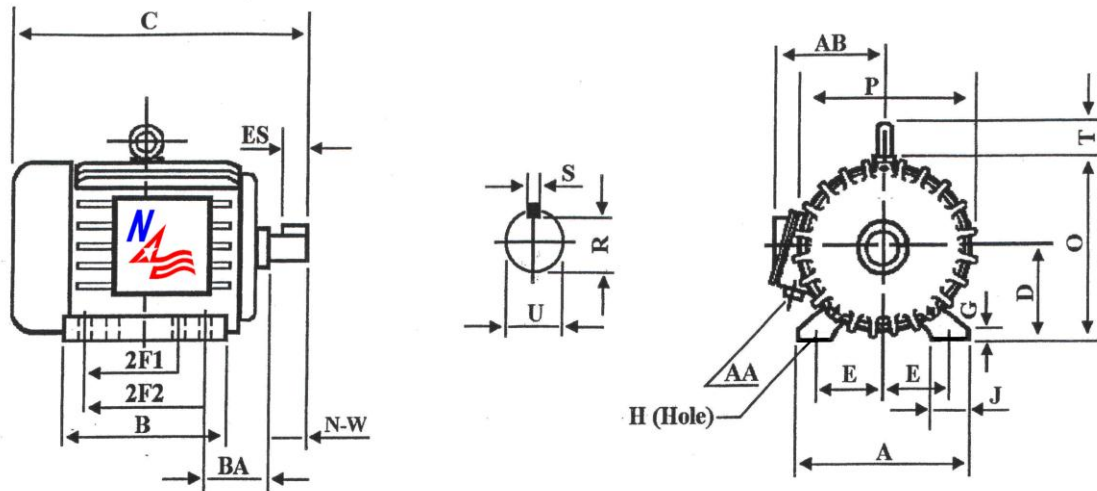

DIMENSIONS – INCHES

A	B	C	D	E	2F1	2F2	G	H	J	O
9	8	17.1	4.5	7.5	4.5	5.5	0.7	0.4	1.8	9
P	R	S	T	U	ES	AA	AB	BA	N-W	Mount
9.8	0.996	0.25	1.6	1.125	1.78	0.75	8.3	2.75	2.75	F1

PERFORMANCE DATA

Three Phase – 60Hz - 208-230/460V – NEMA Design B – Max. Ambient: 40° C

HP	Speed	Frame	NEMA Code	Efficiency (%)			Power Factor			Torque (ft-lb)		
				100%	75%	50%	100%	75%	50%	FLT	BDT%	LRT%
3	1773	182T	K	89.5	89.0	87.5	77.0	70.9	59.7	8.9	250	215
Amps (460V)		DE Bearing	ODE Bearing	Insulation Class	Enclosure Type	Service Factor	Weight (lbs)					
FLA	LRA											
3.8	32	6306-ZZ	6306-ZZ	F	TEFC	1.15	130					



ElectricalHelper

"Practical Straight Forward Electrical Wiring Solutions Since 1928."

For Fast Friendly Assistance
Call Us 888.226.4917
Hours 8:00AM - 5:00PM