



**PE215T-10-4**

GENERAL PURPOSE ELECTRIC MOTOR

NEMA PREMIUM EFFICIENCY

TOTALLY ENCLOSED FAN COOLED

INVERTER DUTY 10:1 CT; 20:1 VT - NEMA MG1 PART 31

Factory Certified for T2B Class I, Division II, Groups A,B,C & D and Class II, Division II, Groups F & G

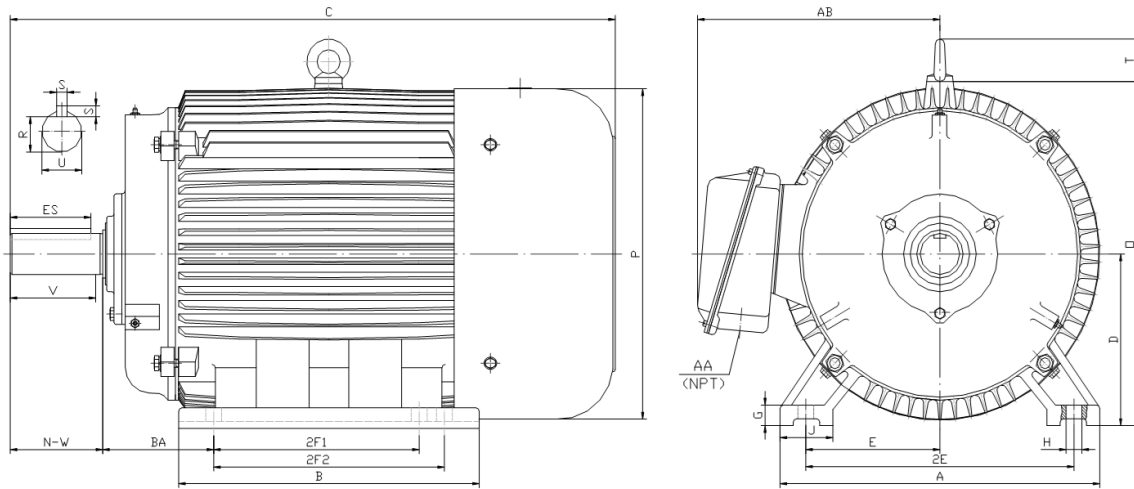

**DIMENSIONS**

HP	RPM	Frame	MOUNTING														
			A	B	C	D	G	H	J	E	2E	2F1	2F2	O	P	T	BA
10	1800	215T	11.00	9.40	20.40	5.25	0.70	0.41	2.40	4.25	8.50	5.50	7.00	11.20	11.60	1.90	3.50

Shaft Extension, Key Set						Conduit Box		Bearings		Mount
U	V	R	S	ES	N-W	AA	AB	DE	ODE	
1.375	3.12	1.201	0.312	2.41	3.38	1.00	9.00	6308-ZZ	6308-ZZ	F1

**BEARING LUBRICATION:** The bearings come lubricated with Mobil Polyrex EM Polyurea Grease.



**ElectricalHelper.org**

For All Your Electric Needs Since 1928  
411 N Platte Ave. York, NE. 68467

AC-DC MOTORS :: SALES & SERVICE  
REWINDING :: CUSTOM CONTROL PANEL

Kelly MacMillan  
Office PH: 888.226.4917 Ext. 102  
Fax: 888.226.4917  
Cell: 402.679.1579  
E-Mail: [kelly@electricalhelper.com](mailto:kelly@electricalhelper.com)



## PE215T-10-4

GENERAL PURPOSE ELECTRIC MOTOR  
NEMA PREMIUM EFFICIENCY  
TOTALLY ENCLOSED FAN COOLED

INVERTER DUTY 10:1 CT; 20:1 VT - NEMA MG1 PART 31







Factory Certified for T2B Class I, Division II, Groups A,B,C & D and Class II, Division II, Groups F & G

### PERFORMANCE DATA

HP	RPM	Frame	Voltage	Frequency (Hz)	Full Load S.F.	Insulation Class	NEMA Design	Slip (%)	NEMA Code	Enclosure Type	IP Rating	Max. Ambient
10	1770	215T	208-230/460	60	1.15	F	B	1.7	H	TEFC	55	40° C

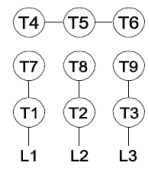
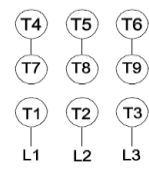
Amps (460V)		Efficiency (%)				Power Factor			Torque (ft-lb)			DE Bearing	ODE Bearing	Connection	Weight (lbs.)
FLA	LRA	100%	75%	50%	Min.	100%	75%	50%	FLT	LRT %	BDT %				
12.0	81	91.7	91.8	90.0	90.2	0.810	0.770	0.670	30.0	170	280	6308-ZZ	6308-ZZ	9 Lead 2Y/Y	178

### NAME PLATE

 										CONNECTION DIAGRAMS		
INVERTER DUTY 20:1 VT; 10:1 CT												
CAT NO: PE215T-10-4			FRAME 215T			PHASE 3				<p>208-230V</p>  <p>460V</p> 		
HZ 60	S.F. 1.15	HZ 50	S.F. 1.0	ENCL TEFC	IP 55							
HP 10	RPM 1770	HP 10	RPM 1460	DUTY CONT	DES B							
VOLTS 208-230/460		VOLTS 190/380		AMB 40° C	INS F							
FLA 26 - 24 / 12	FLA 30/15		DE BEARING 6308-ZZ									
CODE H	P.F. 0.81	CODE F	P.F. 0.84	ODE BEARING 6308-ZZ								
EFF 91.7	MIN 90.2	EFF 89.7	MIN 88.2	LUB: Mobil Polyrex EM								
MOTOR WEIGHT 178 LBS		CONNECTION 9 Lead 2Y/Y		SER NO								
<p>General purpose use on industrial machinery installed in damp, dusty or dirty environments.</p>    <span style="float: right;">CC 082A</span>												

#### APPLICATIONS:

General purpose use on pumps, fans, blowers, compressors, conveyors, material handling and other industrial machinery installed in damp, dusty or dirty environments.



**ElectricalHelper.org**

For All Your Electric Needs Since 1928

411 N Platte Ave. York, NE. 68467

AC-DC MOTORS :: SALES & SERVICE

REWINDING :: CUSTOM CONTROL PANEL

Kelly MacMillan

Office PH: 888.226.4917 Ext. 102

Fax: 888.226.4917

Cell: 402.679.1579

E-Mail: [kelly@electricalhelper.com](mailto:kelly@electricalhelper.com)